

Article number: 51030354000010
Description: Vibration damper GS-M2
70x60x2000-5, NR shore 57

Measures

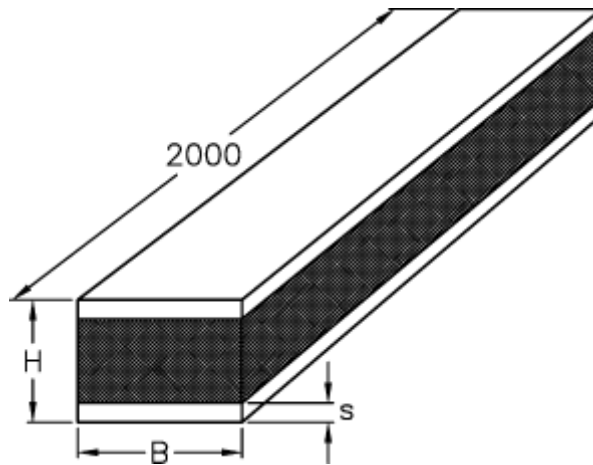

B = 70
H = 60
S = 5